

## Tyra reflector series for Cree MPL series of LEDs

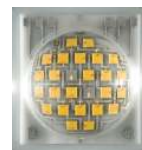

- Specially designed for XLamp MP-L EasyWhite series of LEDs.
- Special design care taken to make a uniform visually pleasing illumination.
- Compact dimensions and easy mounting to TYCO solderless LED socket using location pins.
- Reflector is made of aluminum coated PC (120°C/248F) with protective laquer (110°C/230F)

Read more about TYCO Solderless LED socket from here:

[http://www.tycoelectronics.com/commerce/DocumentDelivery/DDEController?Action=srchtrv&DocNm=5-1773457-1\\_SOLDERLESS\\_LED\\_SOCKET&DocType=DS&DocLang=&s\\_cid=1046](http://www.tycoelectronics.com/commerce/DocumentDelivery/DDEController?Action=srchtrv&DocNm=5-1773457-1_SOLDERLESS_LED_SOCKET&DocType=DS&DocLang=&s_cid=1046)

## LENS TYPE

NAME	ORDERING CODE	FWHM Angle
Tyra Spot	C11394_Tyra-S	±10°
Tyra Diffused Spot	C11528_Tyra-SD	±15.5
Tyra Medium	C11395_Tyra-M	±16°
Tyra Wide	C11396_Tyra-W	±26°

EULUMDAT & IES FILES AVAILABLE BY REQUEST

© Ledil Oy – PRELIMINARY - Subject to change without prior notice

## MEASUREMENTS

Relative Intensity of C11394\_Tyra-S

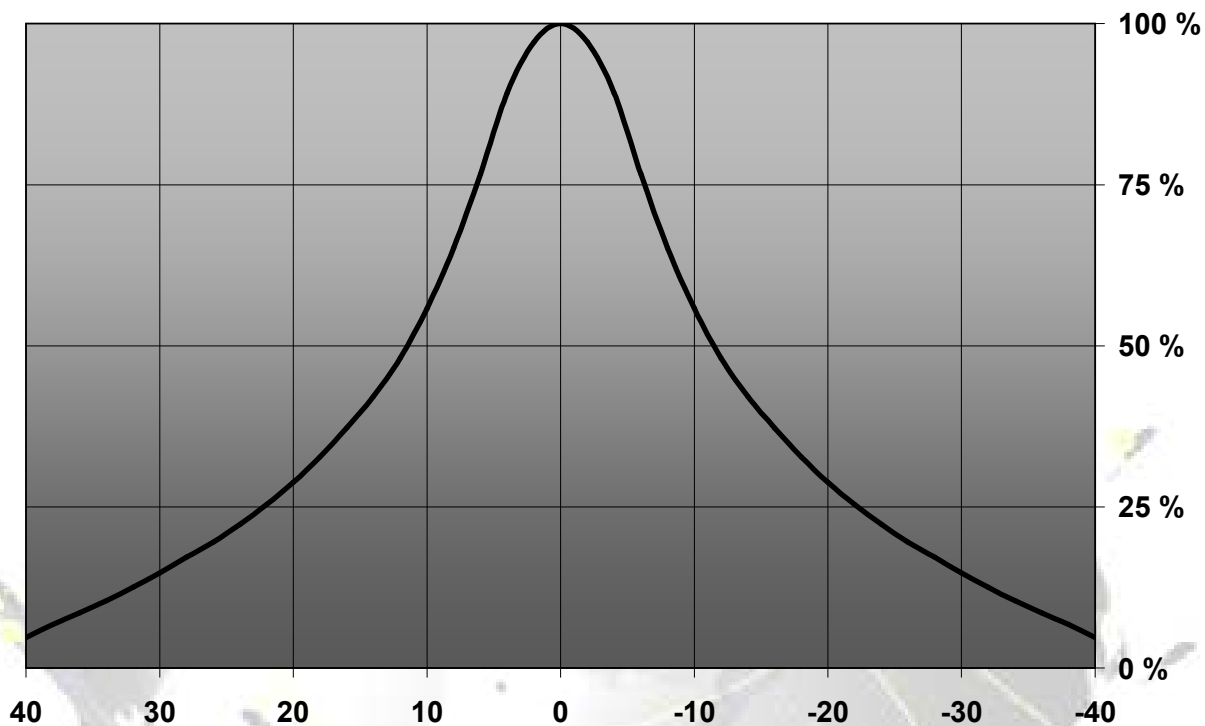

© Ledil Oy – PRELIMINARY - Subject to change without prior notice

Relative Intensity of C11528\_Tyra-SD

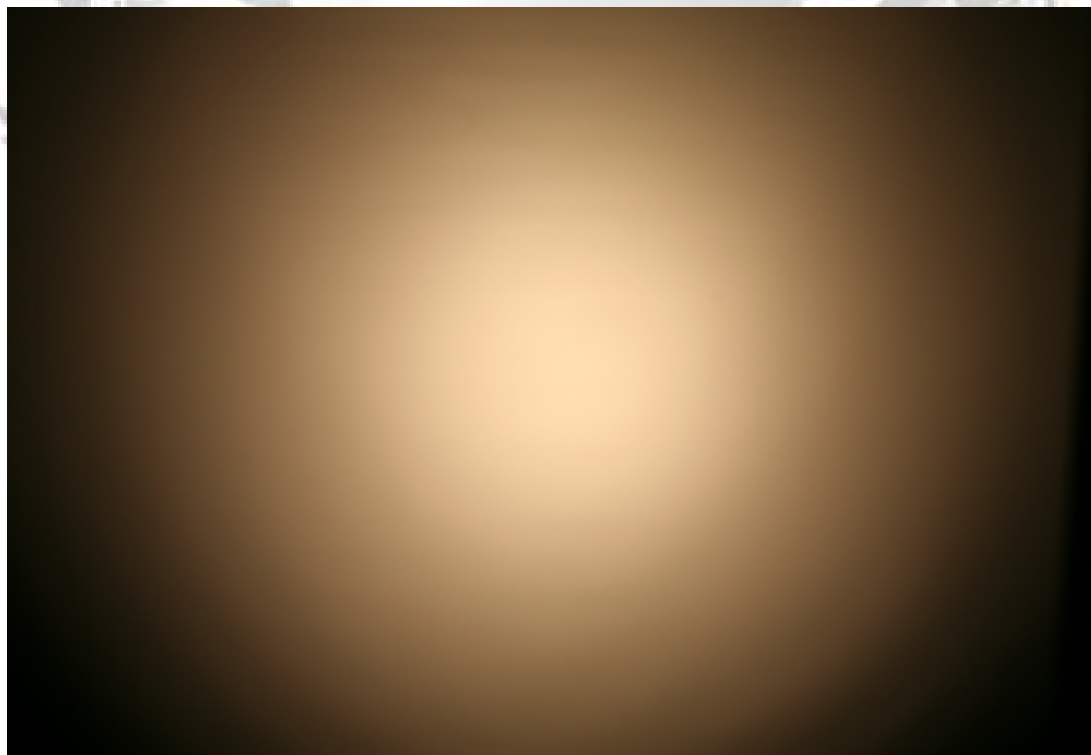
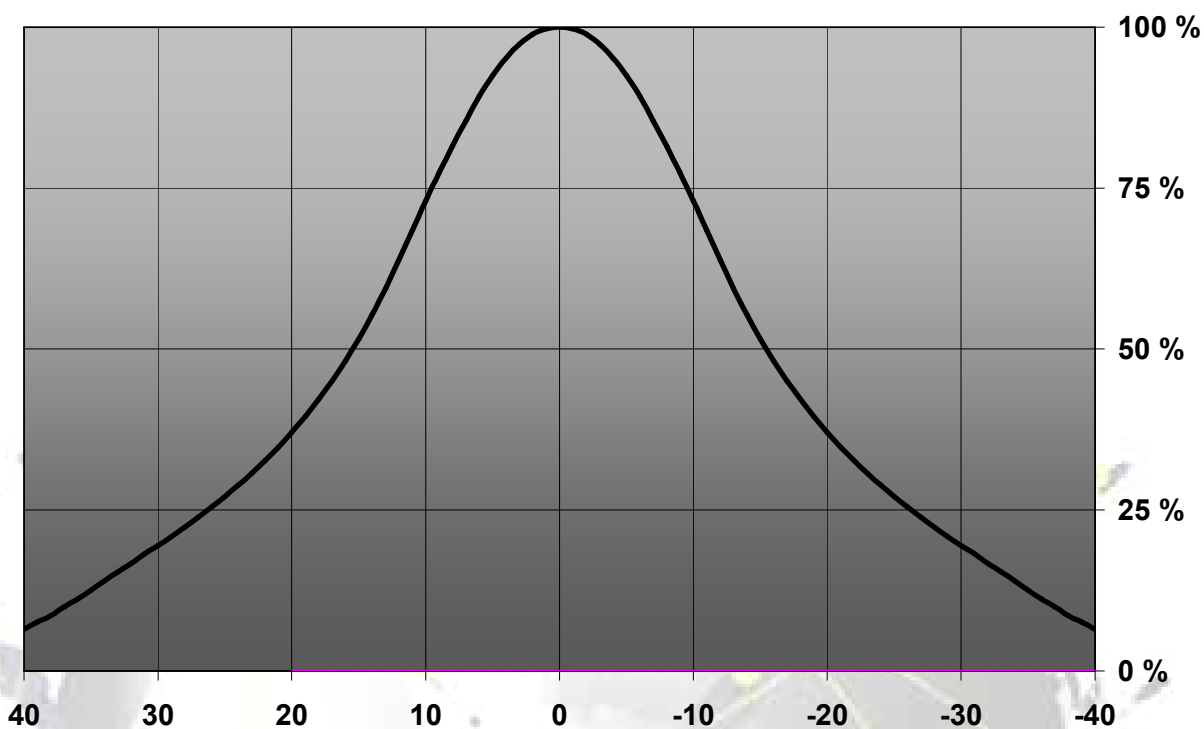

© Ledil Oy – PRELIMINARY - Subject to change without prior notice

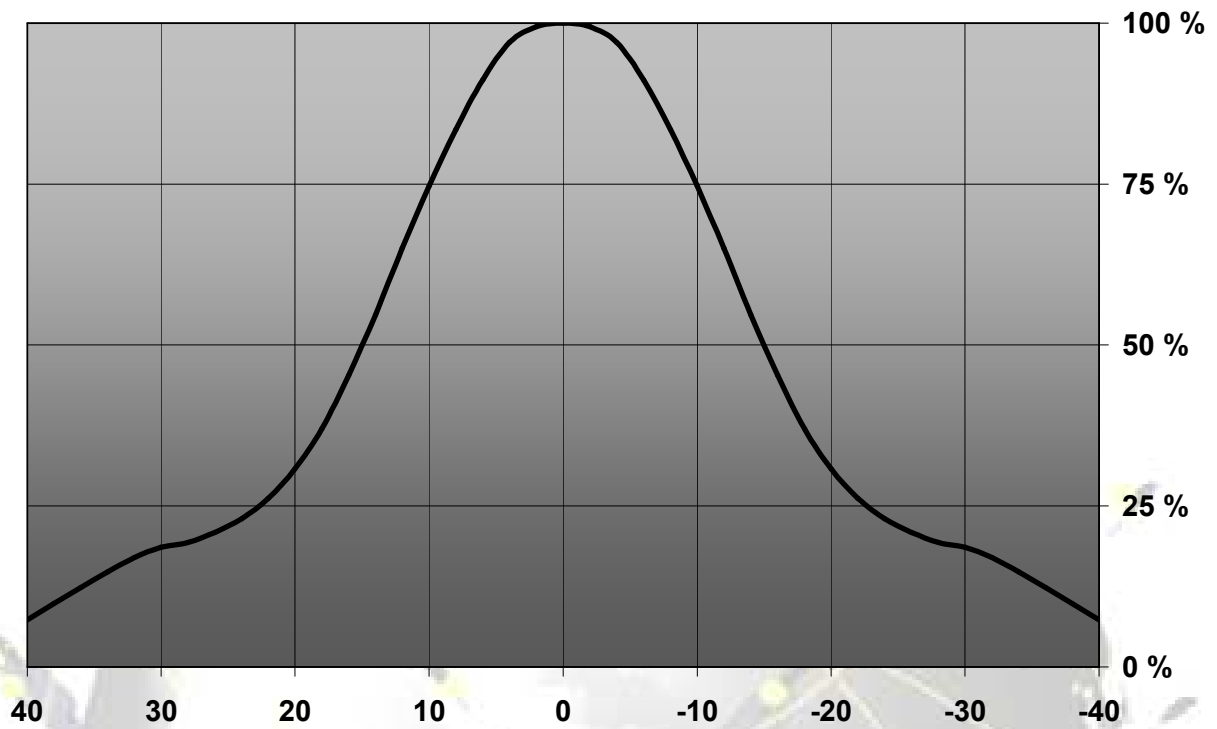
**Relative Intensity of C11395\_Tyra-M**

© Ledil Oy – PRELIMINARY - Subject to change without prior notice

Relative Intensity of C11396\_Tyra-W

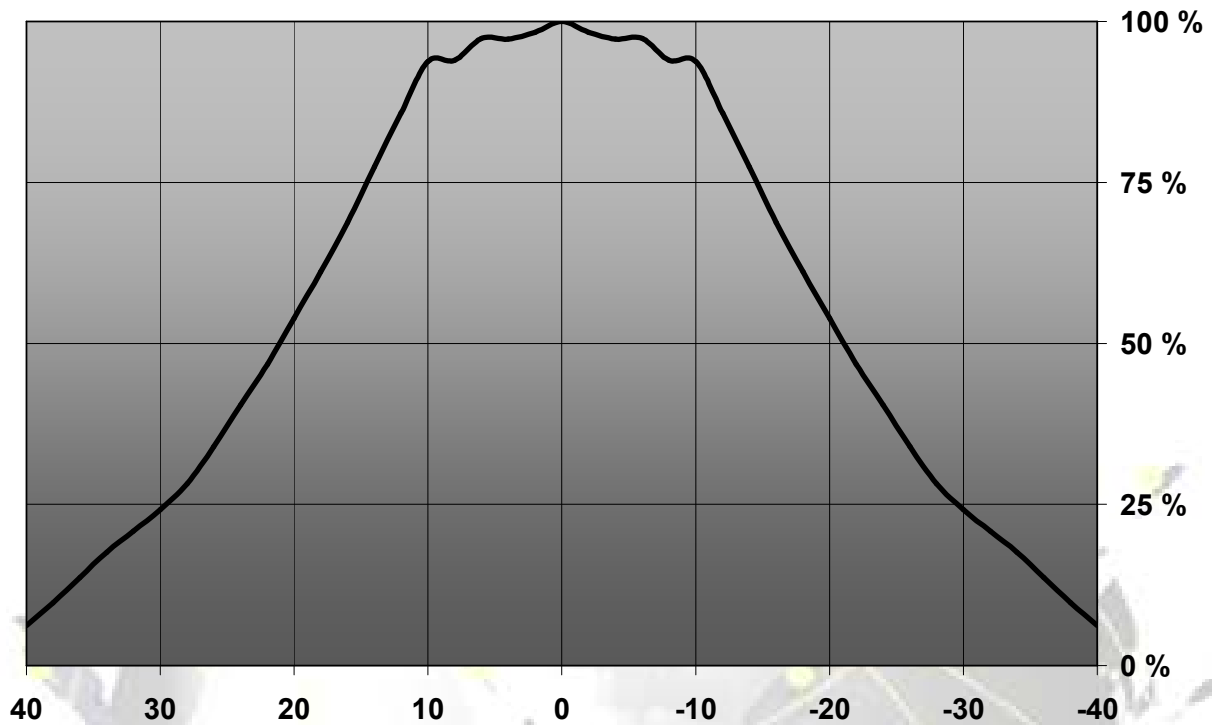

© Ledil Oy – PRELIMINARY - Subject to change without prior notice

## DRAWINGS

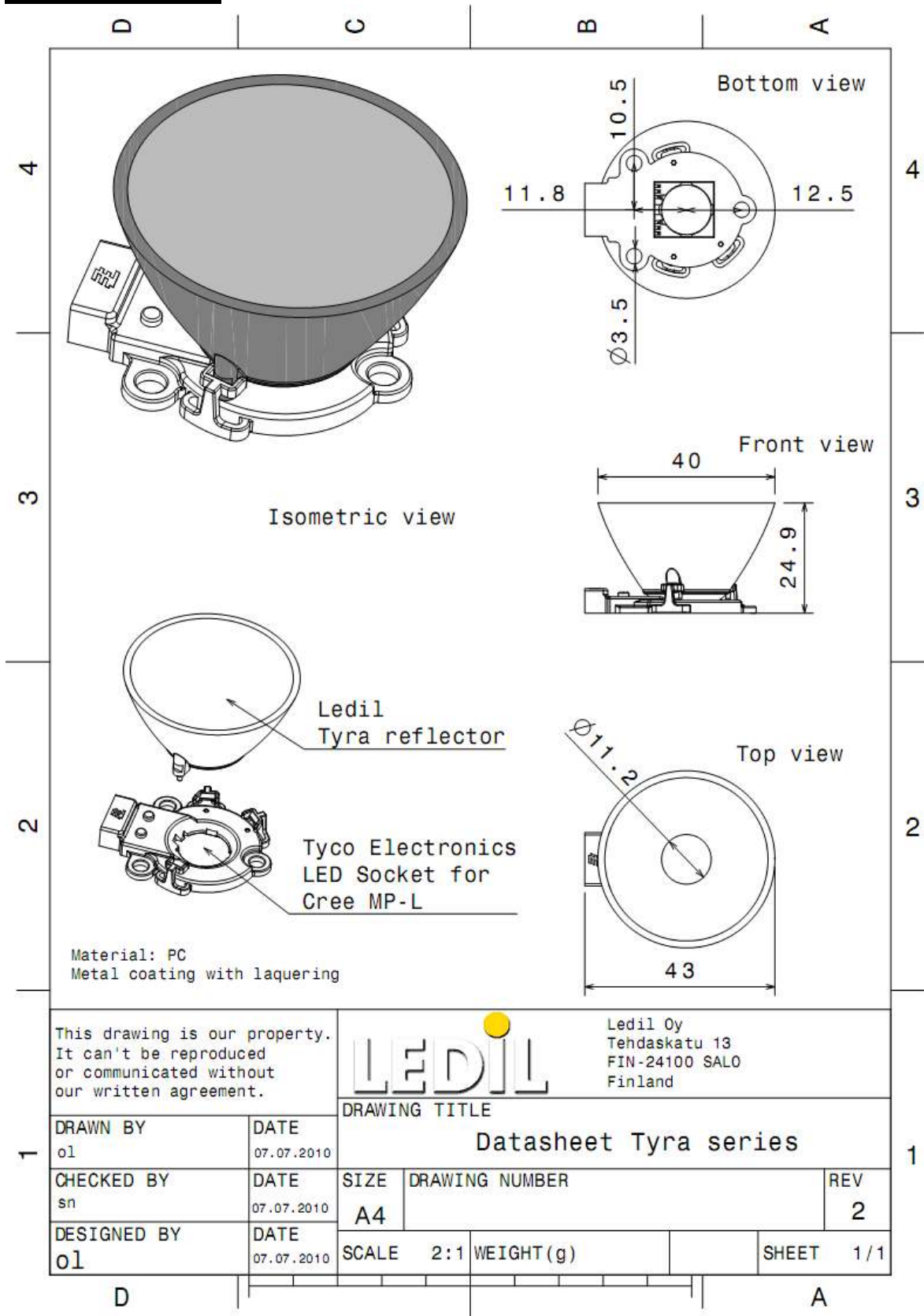

© Ledil Oy – PRELIMINARY - Subject to change without prior notice